

SAGINAW CONTROL & ENGINEERING SCE-90XMR2D24

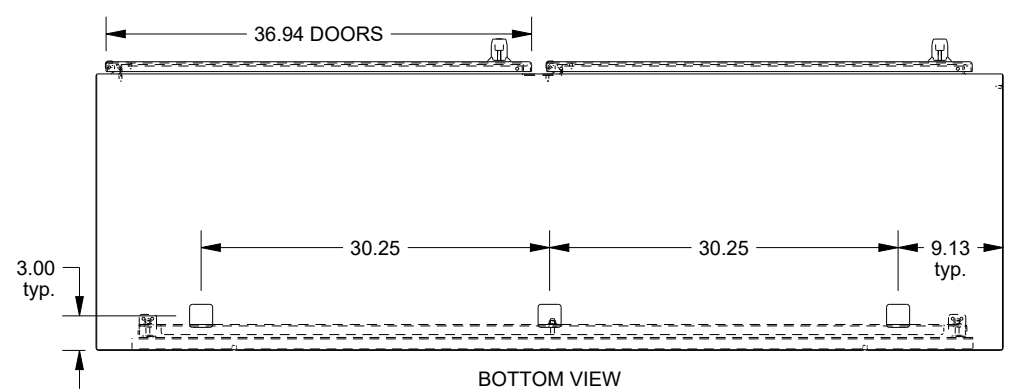
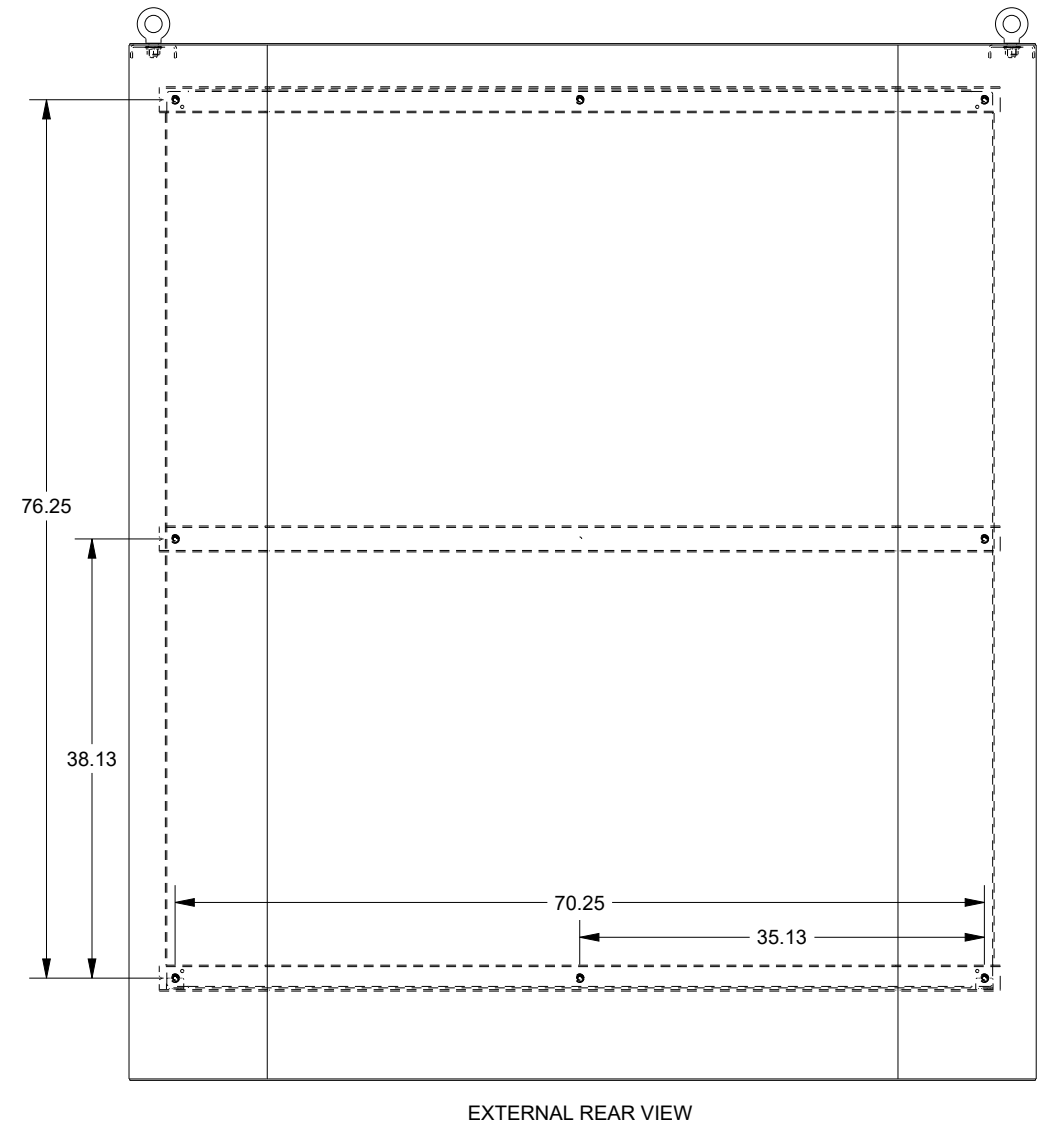
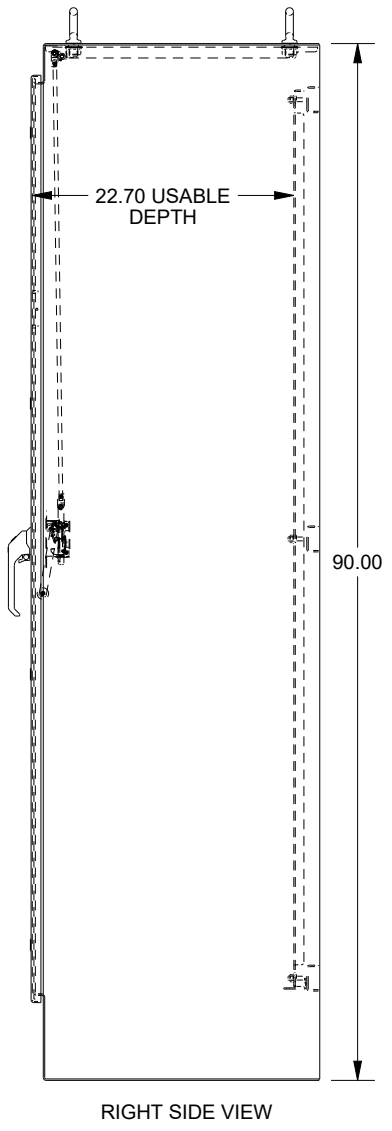
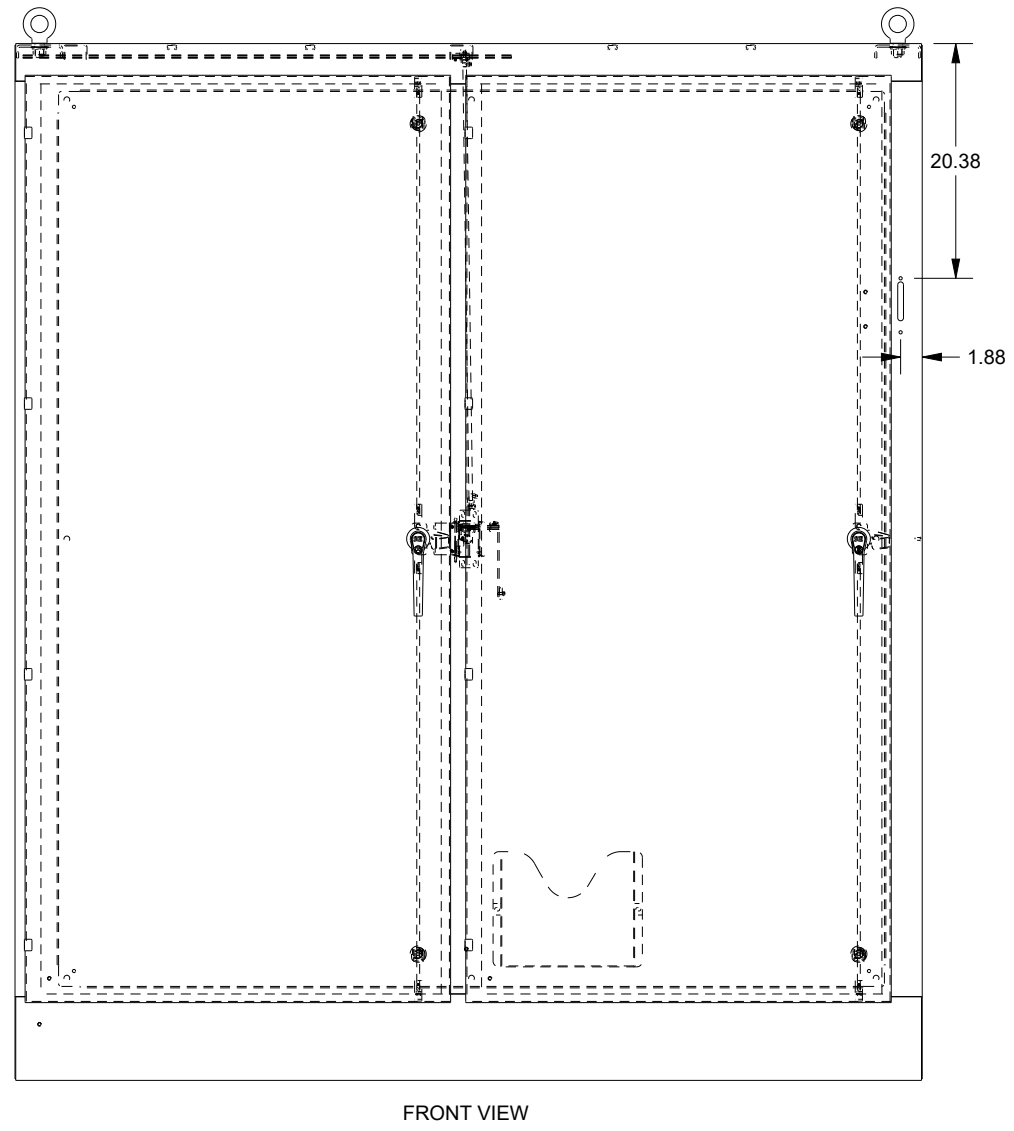
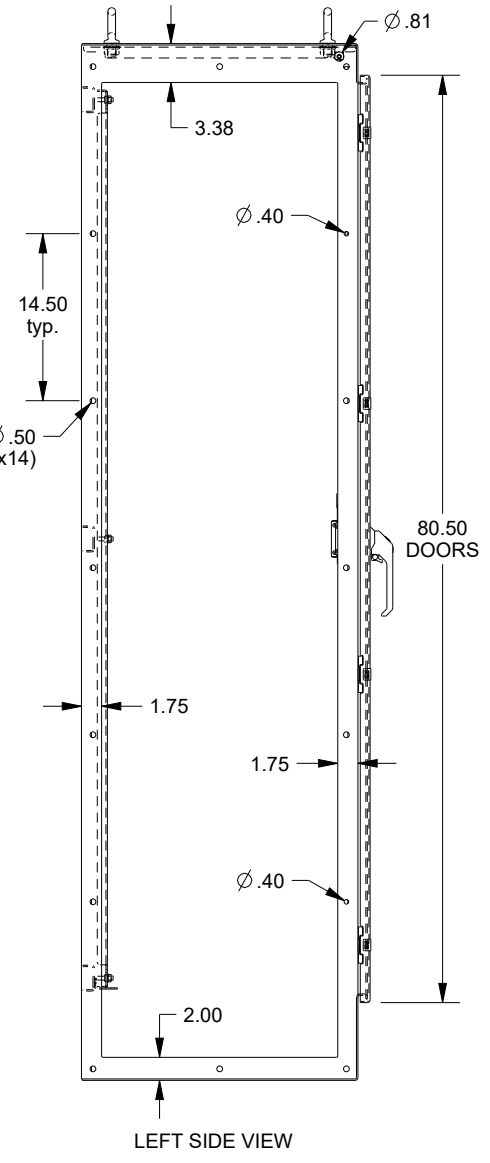
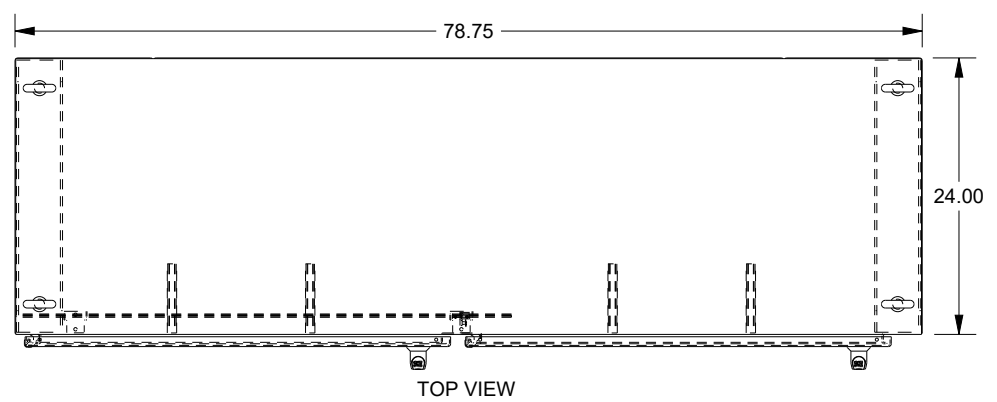

WASH SYSTEM 2" SQUARE DRAIN HOLES
IN THE BOTTOM WITH UL APPROVED
HOLE SEALS PROVIDED